



INSTRUCTIONS D'ASSEMBLAGE
ASSEMBLY INSTRUCTIONS

MONARCH
SPECIALTIES INC.

I 2425

ETAGERE -
60"H / ETAGERE EN COIN D'APPOINT BLANC

BOOKCASE -
60"H / WHITE CORNER ACCENT ETAGERE







**POUR DE L'ASSISTANCE OU POUR COMMANDER
DES PIÈCES CONTACTEZ NOTRE DÉPARTEMENT
DE SERVICE À LA CLIENTÈLE.**

**FOR ASSISTANCE OR TO ORDER PARTS
CONTACT OUR CUSTOMER SERVICE DEPARTMENT**

WWW.MONARCHSERVICE.COM

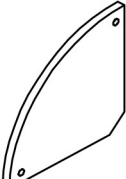
LISTE DES PIÈCES
PARTS LIST

PIÈCE / PART #	IMAGE	DESCRIPTION	QTY / QTÉ
1		TOP SHELF ÉTAGÈRE SUPÉRIEURE	1
2		SHELF PANEL PANNEAU DE TABLETTE	1
3		SHELF PANEL PANNEAU DE TABLETTE	1
4		SHELF PANEL PANNEAU DE TABLETTE	1
5		BOTTOM SHELF ÉTAGÈRE DU BAS	1

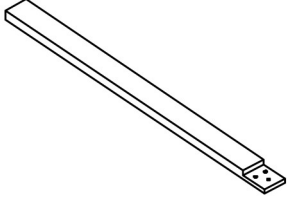
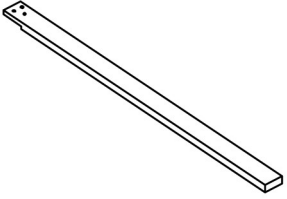
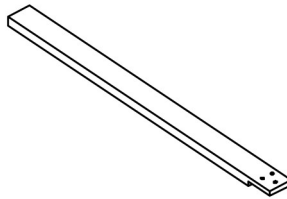
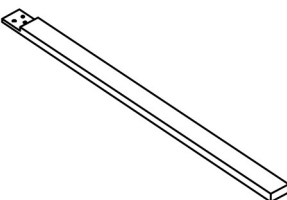
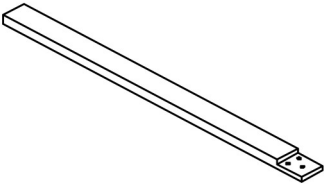

LISTE DES PIÈCES
PARTS LIST

PIÈCE / PART #	IMAGE	DESCRIPTION	QTY / QTÉ
6		FRONT FACING LEFT LEG PATTE AVANT GAUCHE	1
7		FRONT FACING LEFT LEG PATTE AVANT GAUCHE	1
8		FRONT FACING RIGHT LEG PATTE AVANT DROITE	1
9		FRONT FACING RIGHT LEG PATTE AVANT DROITE	1
10		BACK LEG SUPPORT BARRE DE SOUTIEN ARRIERE (TABLE)	1

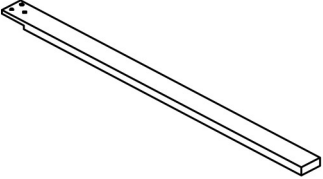
LISTE DES PIÈCES
PARTS LIST

PIÈCE / PART #	IMAGE	DESCRIPTION	QTY / QTÉ
11		BACK LEG SUPPORT BARRE DE SOUTIEN ARRIERE (TABLE)	1

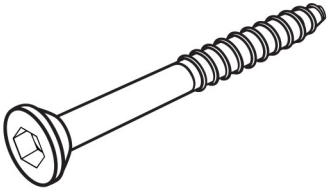
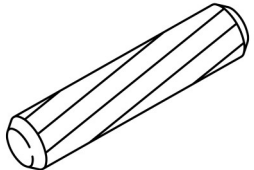
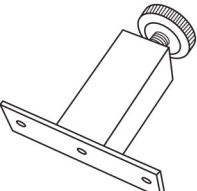

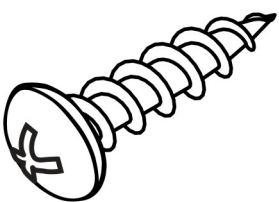
LISTE DES PIÈCES DE MONTAGE
HARDWARE LIST

PIÈCE / PART #	IMAGE	DESCRIPTION	QTY / QTÉ
A		ASSEMBLING SCREW - Ø1/4" X 2 5/8" VIS D'ASSEMBLAGE - Ø1/4" X 2 5/8"	9
B		WOOD DOWEL - Ø3/8" X 1" GOUJON DE BOIS - Ø3/8" X 1"	15
C		SUPPORT LEG - 3 1/8" X 1" PATTE DE SOUTIEN - 3 1/8" X 1"	1
D		ASSEMBLING SCREW - Ø1/8" X 5/8" VIS D'ASSEMBLAGE - Ø1/8" X 5/8"	2
E		ASSEMBLING SCREW - Ø1/8" X 1" VIS D'ASSEMBLAGE - Ø1/8" X 1"	1

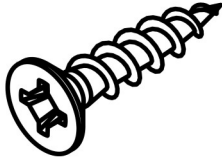
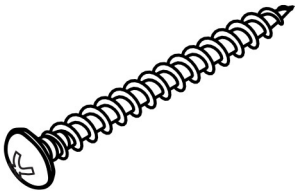
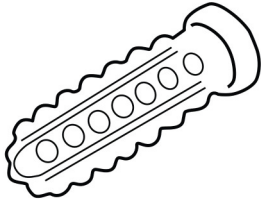
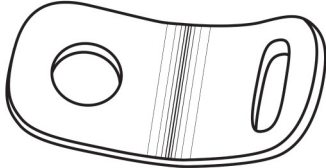
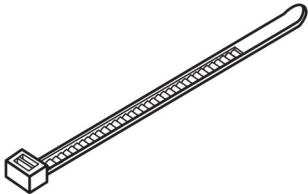
LISTE DES PIÈCES DE MONTAGE
HARDWARE LIST

PIÈCE / PART #	IMAGE	DESCRIPTION	QTY / QTÉ
F		ASSEMBLING SCREW - Ø1/8" X 1 1/2" VIS D'ASSEMBLAGE - Ø1/8" X 1 1/2"	6
G		ASSEMBLING SCREW - Ø1/8" X 1 1/2" VIS D'ASSEMBLAGE - Ø1/8" X 1 1/2"	1
H		ANCHOR - Ø3/8" X 1 1/2" ANCRE - Ø3/8" X 1 1/2"	1
I		METAL BRACKET - 1/2" X 1/2" SUPPORT DE MÉTAL - 1/2" X 1/2"	2
J		ZIP TIE - 7 3/4" X 1/8" ATTACHE AUTOBLOQUANTE - 7 3/4" X 1/8"	1

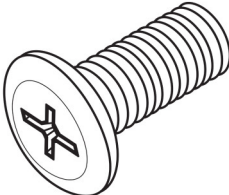
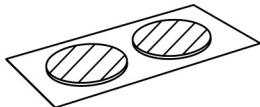
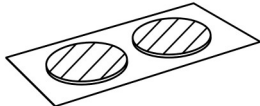
LISTE DES PIÈCES DE MONTAGE
HARDWARE LIST

PIÈCE / PART #	IMAGE	DESCRIPTION	QTY / QTÉ
K		BARREL NUT - Ø1/4" ÉCROU DE CANON - Ø1/4"	9
L		ASSEMBLING BOLT - Ø1/4" X 1/2" BOULON D'ASSEMBLAGE - Ø1/4" X 1/2"	9
M		FINISHING STICKER - Ø3/4" COLLANT DE FINITION - Ø3/4"	18
N		FINISHING STICKER - Ø1/2" COLLANT DE FINITION - Ø1/2"	6
O		BARREL NUT - Ø1/4" X 1/2" ÉCROU DE CANON - Ø1/4" X 1/2"	9

LISTE DES PIÈCES DE MONTAGE
HARDWARE LIST

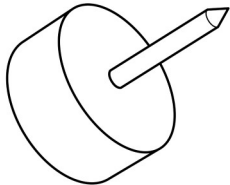
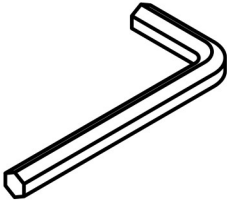
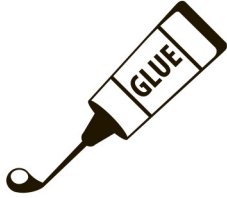
PIÈCE / PART #	IMAGE	DESCRIPTION	QTY / QTÉ
P		<p>FLOOR PROTECTOR - Ø5/8" PROTECTEUR DE PLANCHER - Ø5/8"</p>	3
Q		<p>HEX KEY CLÉ HEXAGONALE</p>	1
R		<p>GLUE COLLE</p>	1

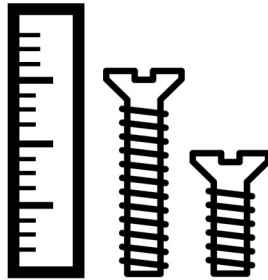

OUTIL DE VÉRIFICATION DE DIMENSIONS DES PIÈCES
HARDWARE DIMENSIONS VERIFICATION TOOL

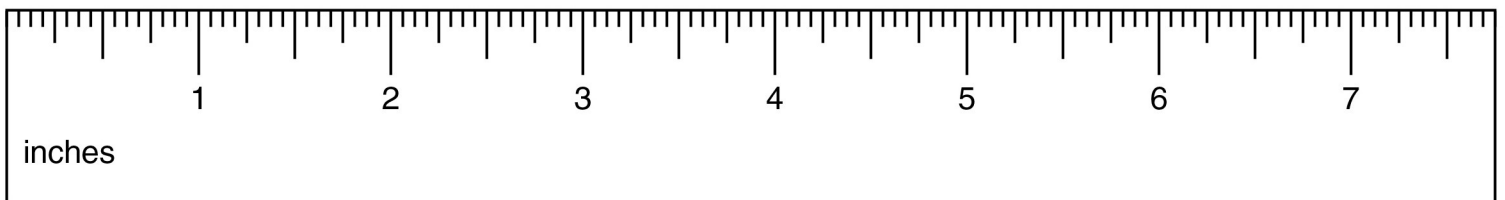

ÉTAPE / STEP 1

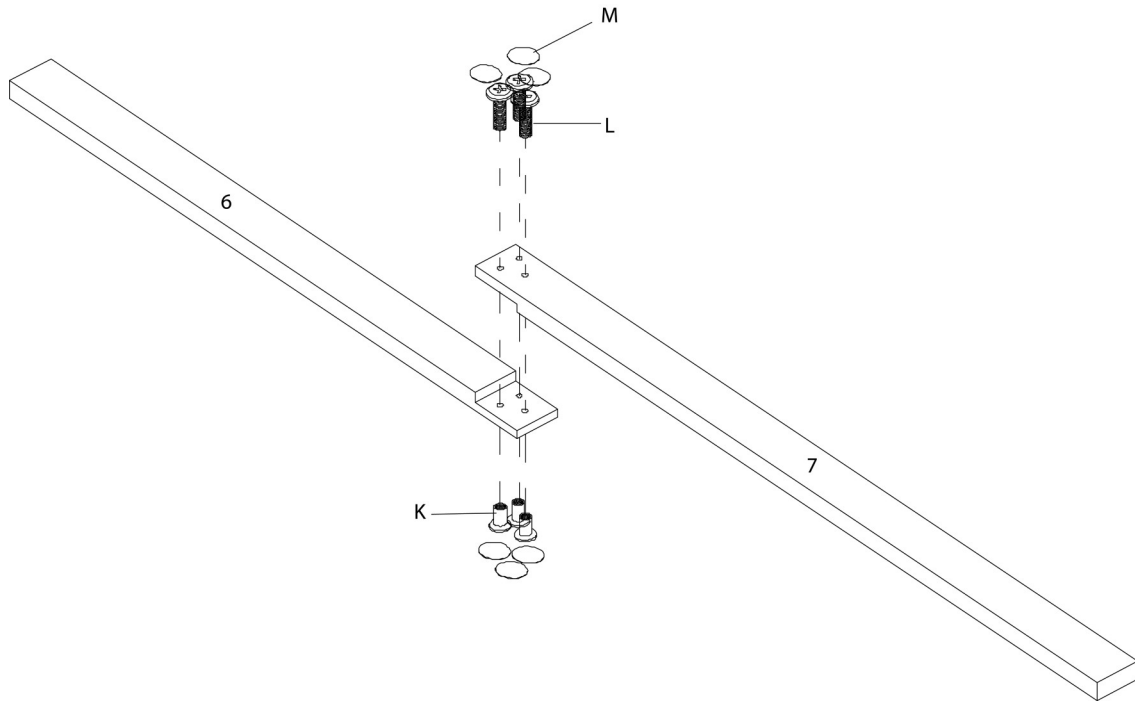

ÉTAPE / STEP 2

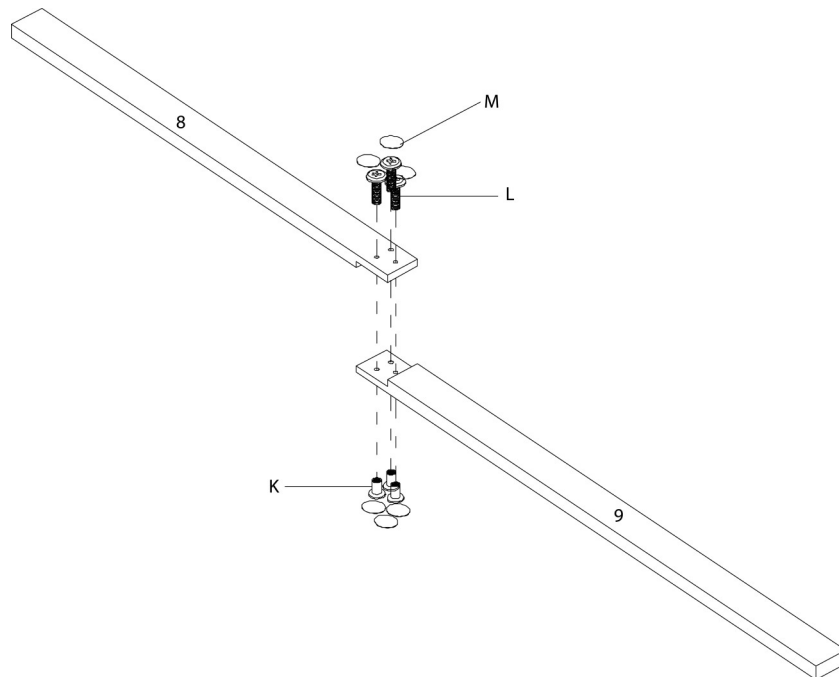

ÉTAPE / STEP 3

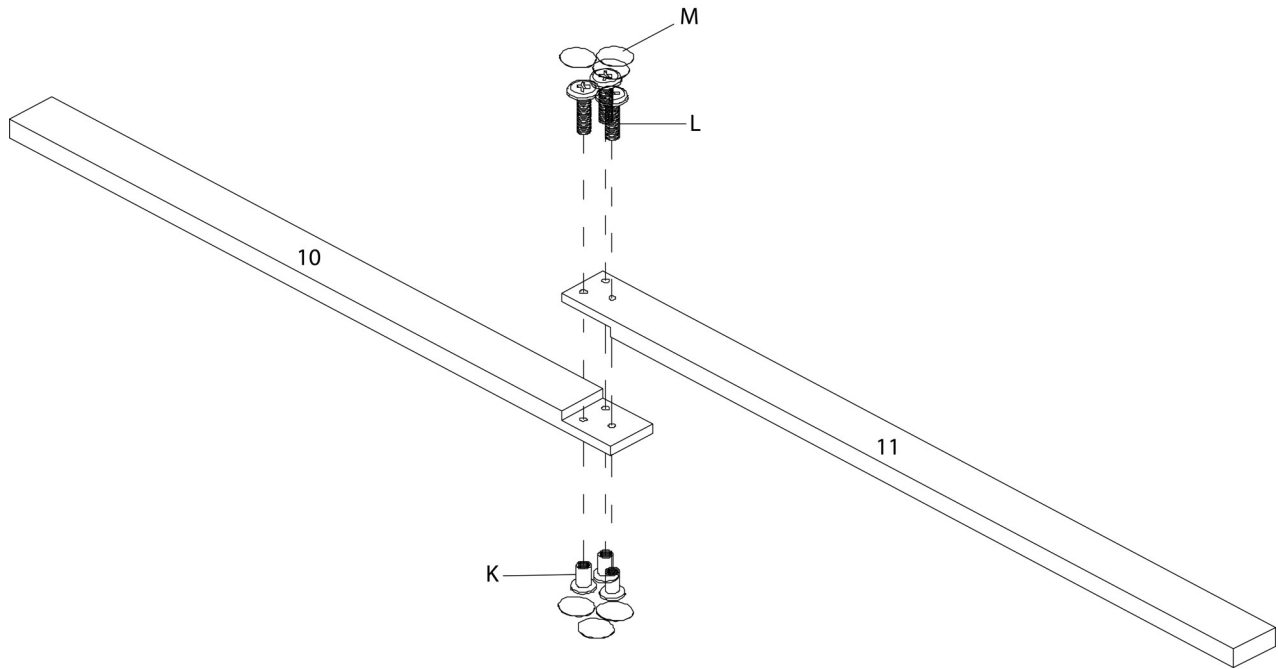

ÉTAPE / STEP 4

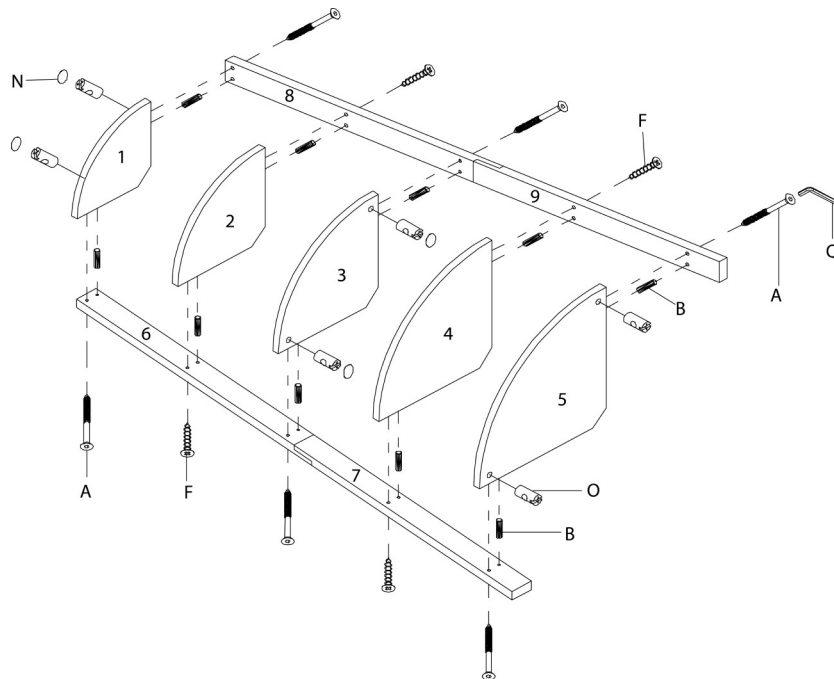

ÉTAPE / STEP 7

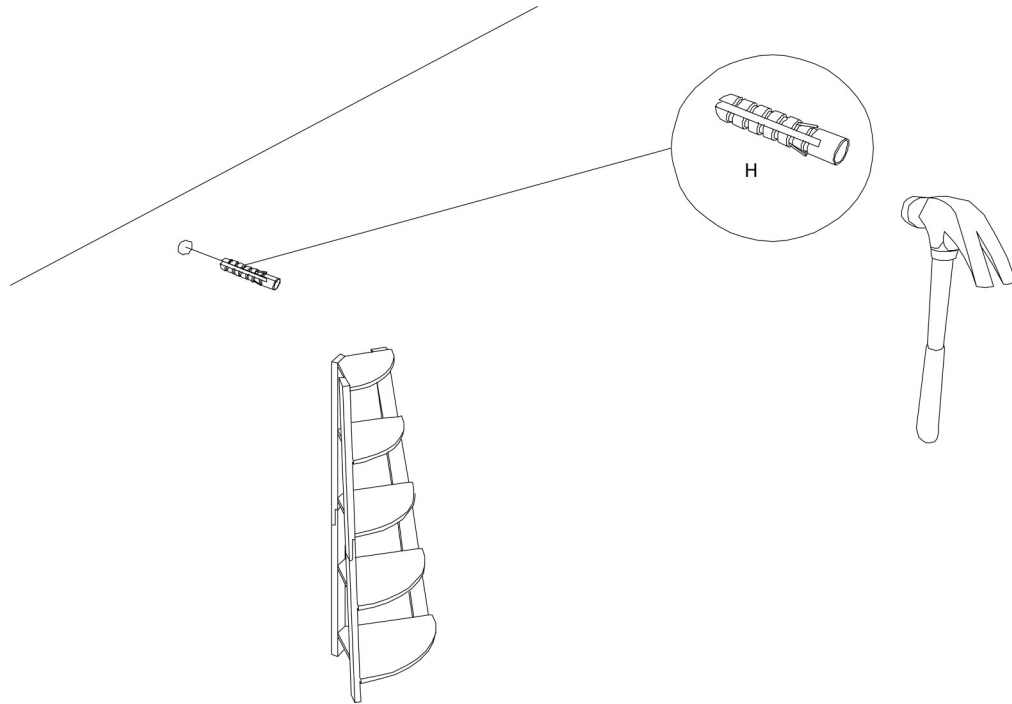

ÉTAPE / STEP 8

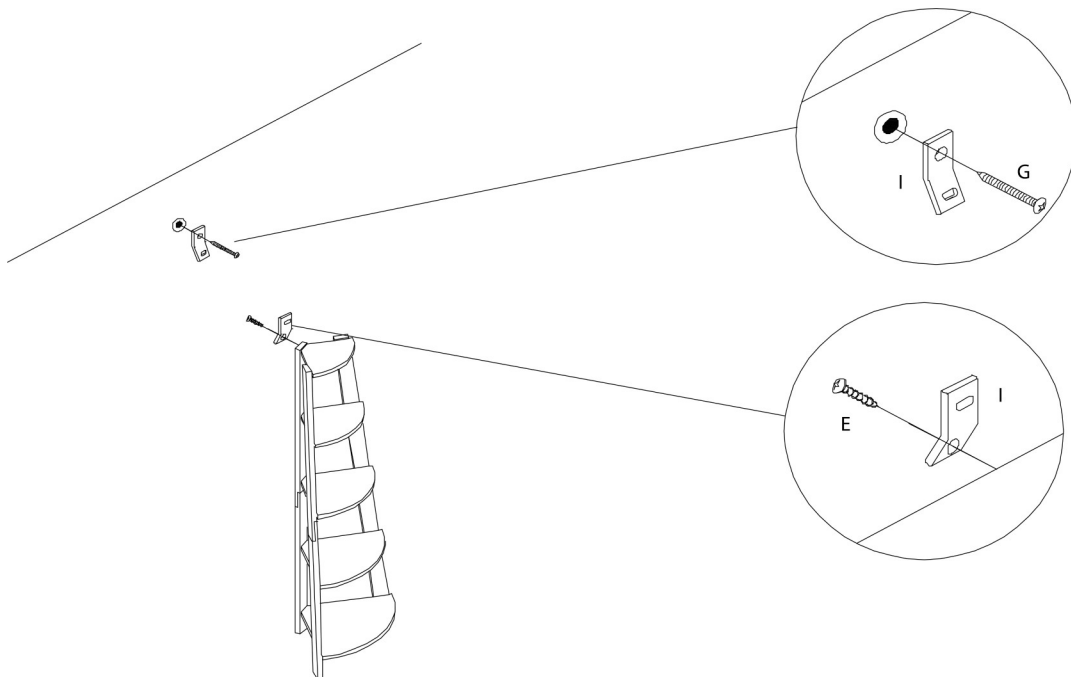

ÉTAPE / STEP 9

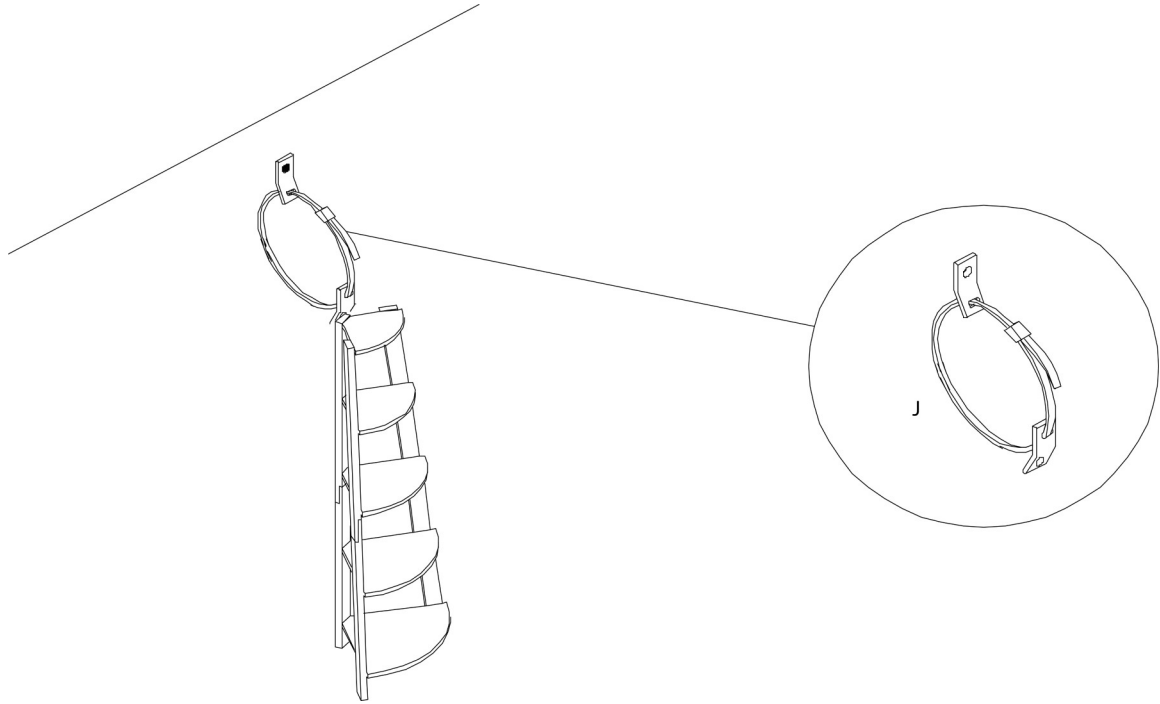

ÉTAPE / STEP 10

