

Assembly Instruction Sheet #S-1153P24 For Style 1153P24

Tools Required: Flathead screwdriver, Phillips screwdriver, pliers, wire cutters, wire strippers, electrical tape, safety glasses.
Light Source: (9) AUOSGRTD LED 60 BULB MAXWZ (Not Include).
Estimated Assembly Time: 20-30 minutes
Preparation: Identify and inspect all parts before beginning installation. Check package content list and diagrams below to be sure all parts are present. If any parts are missing or damaged, do not attempt to assemble, install, or operate the fixture. Contact customer service for replacement parts.

⚠ Warnings and Cautions

Turn off electricity at circuit breaker or main fuse box before installation. Consult a licensed electrician if in doubt. These instructions are provided for your safety. It is very important you read them completely before installing the fixture. We strongly recommend that a licensed, professional electrician perform the installation. Disconnect fixture from power source before replacing bulbs. Make sure bulbs are given sufficient time to cool before removal.

Package Contents

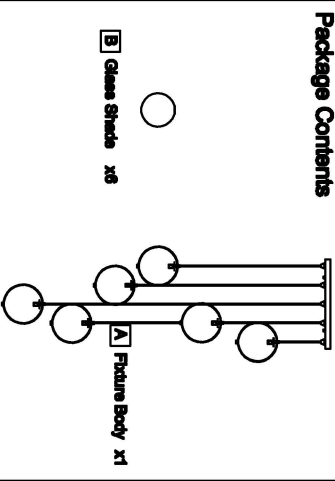

Hardware Contents

PART	DESCRIPTION	QUANTITY
AA	Cap nut	3/pcs
BB	Wire Nut	3/pcs
CC	Outlet Box Screw	2/pcs
DD	Mounting Screw	4/pcs
EE	Mounting bracket	1/pcs
AA		
BB		
CC		
DD		
EE		

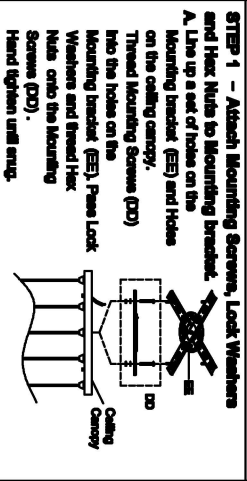

Figure 1

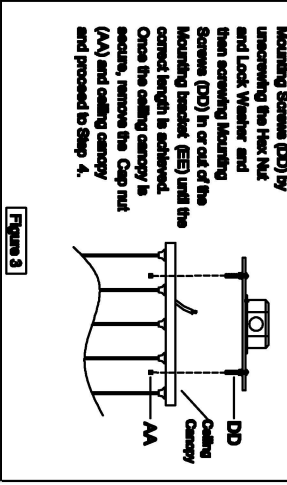

Figure 2

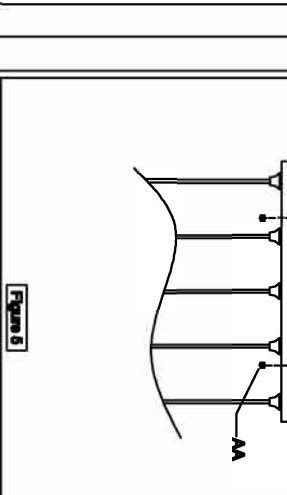

Figure 3

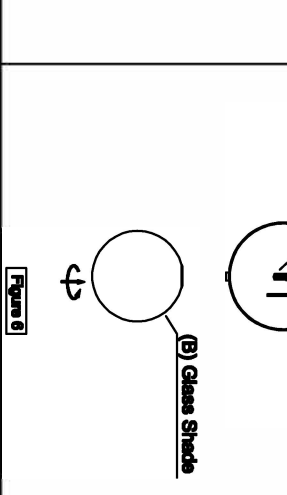

Figure 4

STEP 4 - Wire Connections

A. Use standard wire connections to make all wire connections. Tight connections and wires are tightly joined together. Wrap each connection with approved electrical tape and carefully stuff all the connected wires into the Outlet Box.

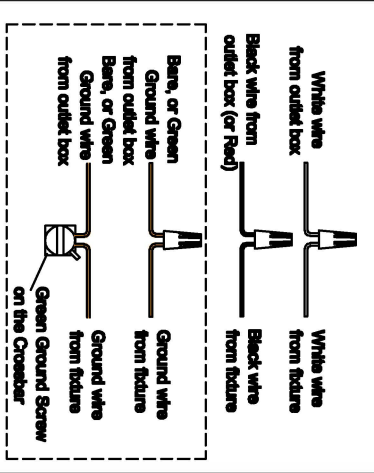

Figure 5

STEP 5 - Install Ceiling Canopy to Ceiling

A. Carefully tuck all wires into the outlet box and position the ceiling canopy of the Fixture Body (A) over the outlet box. Align the holes in the ceiling canopy with the Mounting Screws (DD). Secure with Cap nut (AA) and hand tighten until snug.

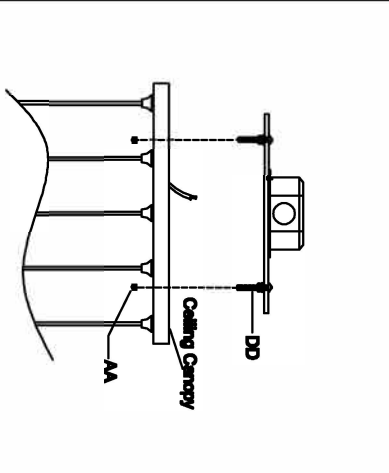

Figure 6

STEP 6 - Install bulb and Glass Shade

A. Install bulb into sockets and screw snug into place.
B. Screw up the Glass Shade with the socket (Be careful the Glass Shade is easy to slip)

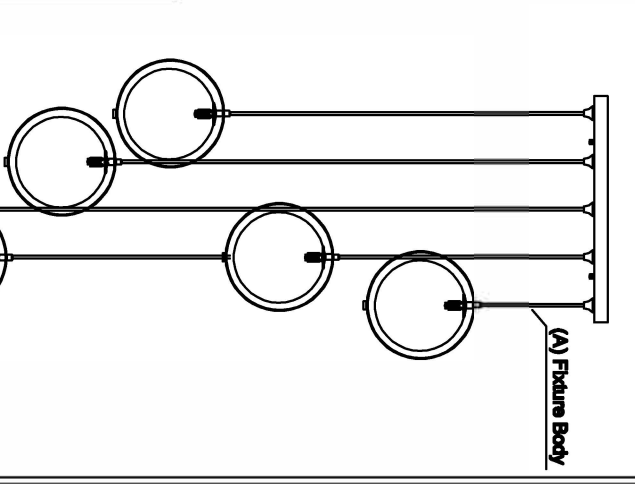

Figure 7